

User Manual

Runcam6

1

Diagram

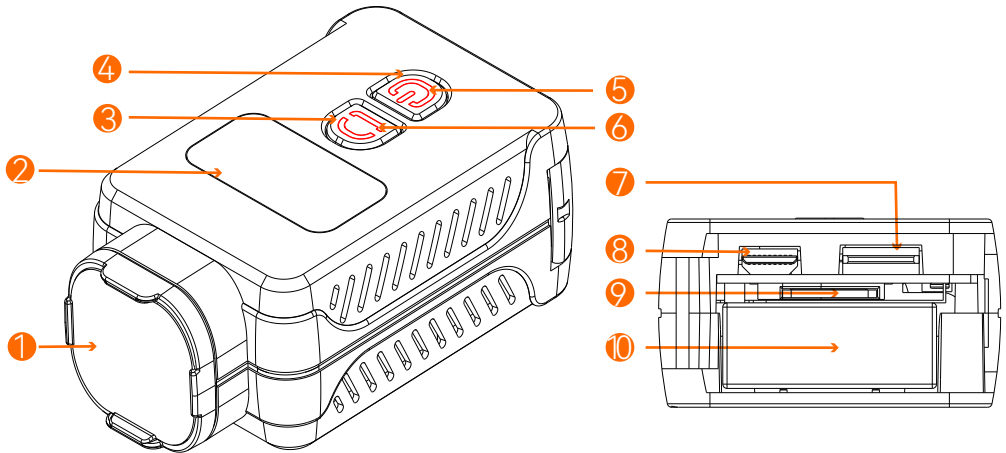

- ① Lens protection hood ③ Wi-Fi/Menu button ⑤ Power light indicator
- ② OLED Display ④ Power/Shutter button ⑥ Wi-Fi/Menu light indicator
- ⑦ Type-C port ⑨ MicroSD card holder
- ⑧ HDMI port ⑩ Battery holder

Power indicator light

Red: recording Green: charging

Wi-Fi/Menu indicator light

Blue: Wi-Fi/Firmware update Orange: menu setting

2

Camera Basic Operations

● Power on/Power of

Long press Power/Shutter button  buzzer beeps 3 times with power light on and camera icon on OLED display, camera is turned on.

Long press the Power/Shutter button  buzzer beeps 5 times with power light and OLED display off, camera is turned off.



● Video mode

After turning on the camera, short press the Power/Shutter button  buzzer beeps once, power light blinks red slowly, OLED display shows recording time, camera starts recording.

When camera records, short press Power/Shutter button  buzzer beeps twice, power light turns solid red, OLED display goes to ready mode, camera stops recording.



● Wi-Fi mode

At standby mode, short press Wi-Fi/Menu button  buzzer beeps once, Wi-Fi/Menu light blinks blue slowly, OLED display shows WiFi icon, the camera turns on Wi-Fi and waits for a connection.

When camera is connected via Wi-Fi, Wi-Fi/Menu light stays solid blue.

At Wi-Fi mode, short press Wi-Fi/Menu button  buzzer beeps once with Wi-Fi/Menu blue light and WiFi icon off, camera turns off Wi-Fi and stays standby.

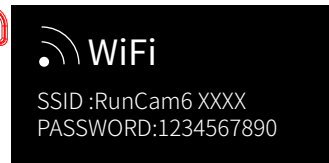

● Menu mode

At standby mode, long press Wi-Fi/Menu button  to enter menu setting mode, buzzer beeps once, Wi-Fi/Menu light turns solid orange, OLED display shows menu setting.

Long press Wi-Fi/Menu button  to quit OLED setting mode, buzzer beeps once with orange Wi-Fi/Menu light off, OLED display and camera go back to standby mode.



● Low power alarm

When the camera is low, the orange light flashes and the buzzer beeps each 3 seconds till camera powers off

● Forced shutdown

When the camera behaves abnormally and both buttons don't give any responses, press both buttons simultaneously to shut down the camera.

● Abnormal conditions

Card error(no card, card full or low-speed card,etc): Red light blinks quickly

Failed Wi-Fi connection: Wi-Fi/Menu light doesn't blink or always stays solid blue

Abnormal booting: Camera fails to detect the lens module, and blue light blinks quickly with OLED display on, camera shuts off in 5 seconds.

3

OLED Display

Display icons

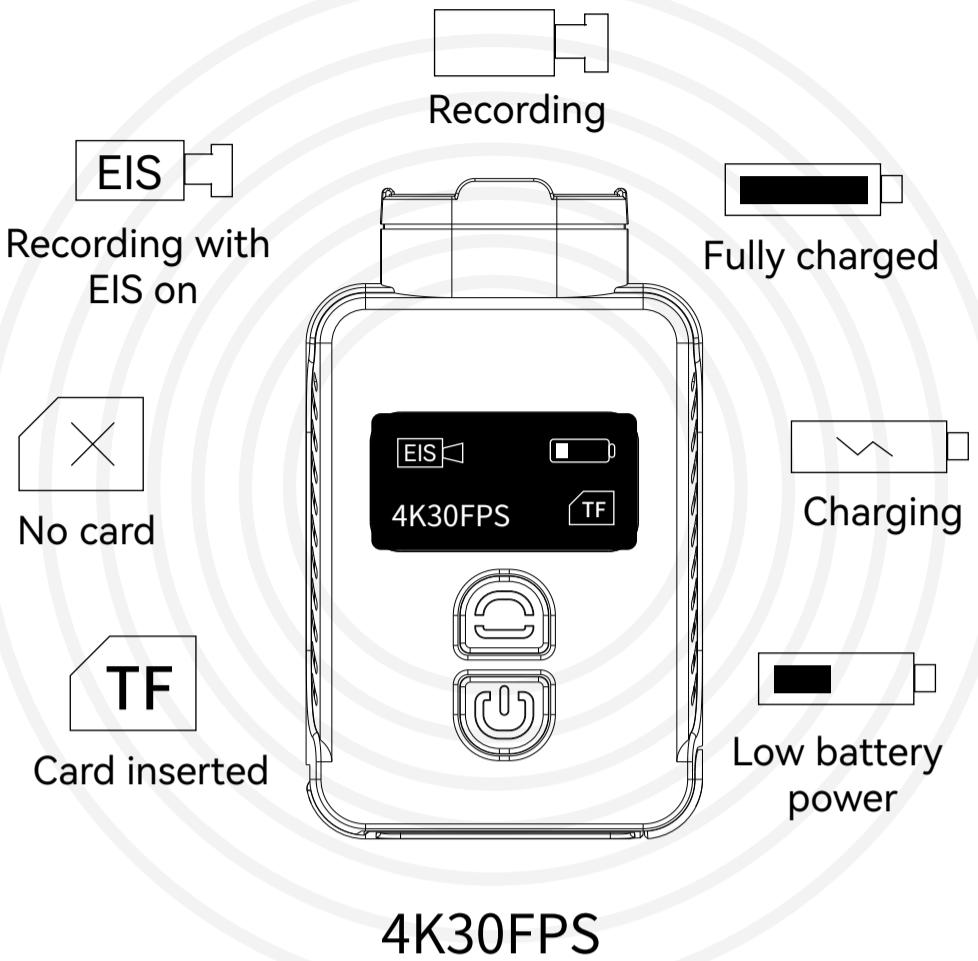

Menu

Resolution	4k
FPS	30
Stabilization	off
Pre-record	off

Wi-Fi

WiFi

SSID :RunCam6 XXXX
 PASSWORD:1234567890

Camera conditions



Firmware update

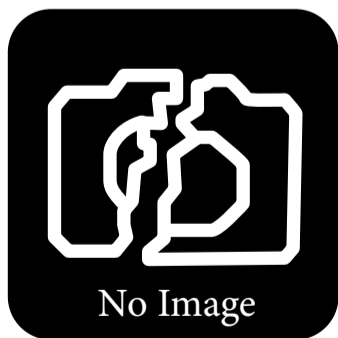

Abnormal booting



U-Disk mode



UVC mode

4

Lens protection hood

Rotate the lens protection hood counterclockwise to remove, rotate it clockwise to install.



5

Battery holder

Push the battery door outward and flip, remove or install the battery.



6

Micro SD Card

MicroSD U3 card is recommended;
Capacity of card is supported up to 512GB.

Notice:

Use carefully when handling memory cards. Avoid liquids, dust, and debris. As a precaution, please power off the camera before inserting or removing the card. Check manufacturer guidelines regarding use in acceptable temperature ranges.

If camera cannot record, please format the used microSD card via RunCam App or computer.

7

Computer Connection

Connect the camera to a computer via Type-C cable, the camera will be recognized as a U-Disk.

Notice:

If the camera cannot be recognized by the computer after connecting, please make sure that a microSD card is inserted well. If you cannot access the files inside the microSD card, please try another Type-C cable or port of PC.

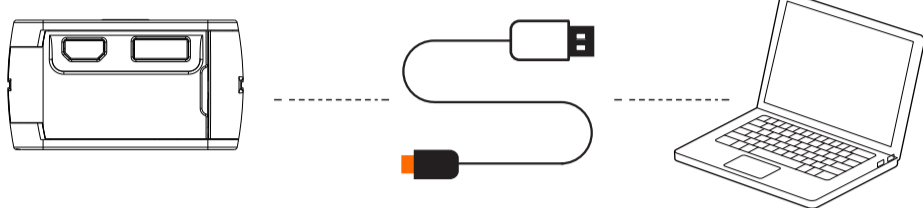

8

Firmware update

For camera's best performance, please use the latest firmware.

Camera firmware update status: Light alternates quick-blinking blue Wi-Fi/Menu light and quick-blinking red Power light, and camera shuts off automatically when the update is finished.

Firmware update method/download and RunCam App:

<https://www.runcam.com/download/Runcam6>

9

GyroFlow Support

- Turn off stabilization

Resolution	4k
FPS	30
Stabilization	off
Pre-record	off

- Use camera to record, and there will be Runcam6_0001.mp4 and Runcam6_0001.gcsv generated.

- Download GyroFlow from <https://gyroflow.xyz/>, install and run the software.



- After stabilizing the recording video via GyroFlow, export the video.

- Please refer to an electronic document for more details.

10

Remote Control

Type-C Control cable instruction

- Power wire
It supports external power input of DC5-18V.
- Ground
Power ground wire / Remote control signal ground wire
- Video
It can be soldered to VI pad of Flight Controller or Video In pad of Video Transmitter to transmit video signal to VTX.
- PWM
It can be soldered to a spare M pad or LED pad of Flight Controller to achieve remote control for camera.
- TX
It can be soldered to a R3 pad or other spare UART of Flight Controller to achieve remote control for camera.
- RX
It can be soldered to a T3 pad or other spare UART of Flight Controller to achieve remote control for camera.



Remote Control via UART (Recommended)

Here we take Flight Controller Speedy Bee-F7 for an example

- Solder the wires of TypeC control cable to the pads on Speedy Bee F7 V3, with Power wire to 5V pad, GND wire to GND pad, Tx wire to R3 pad and Rx wire to T3 pad.

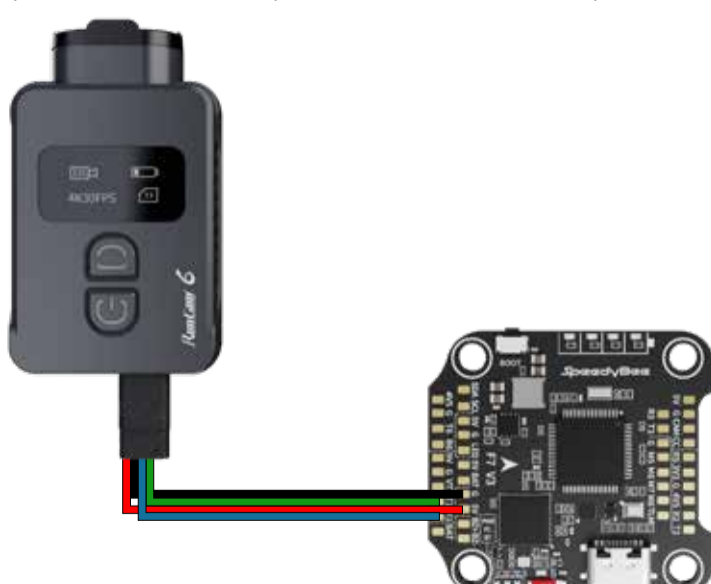

- Use BetaFlight to configure, setting the UART3 of SpeedyBee F7 V3 as RunCam device.

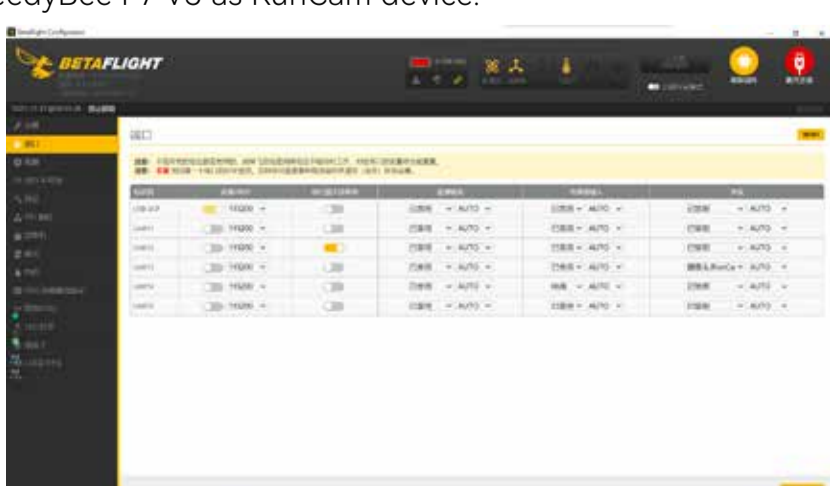

● Configure at Modes

Find the Modes tab at the BetaFlight, and there are three options for camera. Configure each for the functions of camera (select AUX by yourself), and the range is 1900-2100. For example:



● Assign the channels to the switch of the controller

Please choose your Model on the controller, then access to the MIXER interface and assign the channel to the switches. Here we take Radiomaster TX12 as an example, assigning the channels CH5, CH6 and CH7 to SE, SB and SC position respectively.

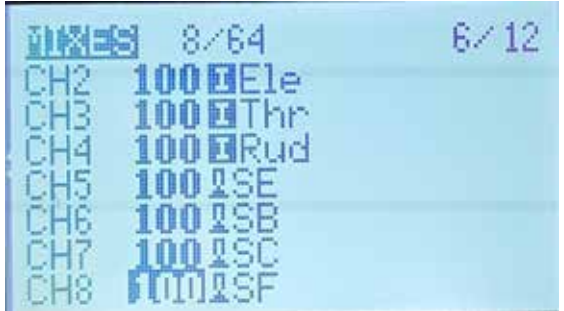

● Test

Power on RunCam 6 and the Flight Controller

- Set the SE to the bottom, the camera starts/stops recording
- Set the SB to the bottom, the camera turns on/off WiFi.
- Set the SC to the bottom, the camera switches among the two modes: video and OSD setting mode; At OSD mode, you can use SA position to select, and use SB to enter a sub-menu or confirm the setting.

PWM Remote Control

Here we take Flight Controller Speedy Bee-F7 for an example

- Solder the wires of TypeC control cable to the pads on Speedy Bee F7 V3, with Power wire to 5V pad, GND wire to GND pad, PWM wire to M6 pad.

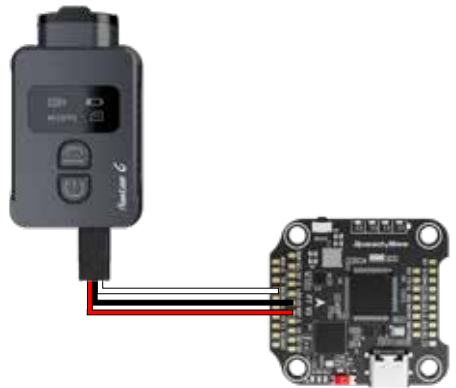

● Configure M6 at CLI mode

- Connect the flight controller to BetaFlight and enter the CLI interface
- Type in resource to proceed, and type the command as below

```
# resource motor 6 none
# resource pinio 2 B05
# set pinio_config = 129,129,1,1
# set pinio_box = 0,41,255,255
# save
```

● Assign the channels to PWM



● Assign the channels to a switch of the controller

Please choose your Model on the controller, then access to the MIXER interface and assign the channel to a switch. Here takes Radiomaster TX12 as an example, assigning CH7 to SF position.

● Test

Set the SF to the bottom, toggle the switch once, camera starts/stops recording; toggles the switch three times, camera will switch to photo mode.

11 RunCam App Connection

1. After turning on the camera, short press the Wi-Fi/Menu button to turn on the Wi-Fi. The Wi-Fi light indicator will blink blue slowly, and camera waits for a connection on mobile device.
2. Go to WLAN/Wi-Fi setting of a mobile phone and find Runcam6_XXXXXXX device to connect, type in the password 1234567890
3. Turn to RunCam App, select RunCam 6 as the camera model to connect. Preview and configuration will be available after a successful connection.

12 RunCam App Download

RunCam App supports both Android and iOS system. Please search and download RunCam App at GooglePlay/ AppStore.

13 Product Support

Please visit: <https://support.runcam.com/hc/en-us>

14 Specifications

Model	Runcam6
Image Sensor	SOIY IMX 377 1/2.3" 1200W
Resolutions	4K@30FPS/2.7K@60FPS/2.7K@30FPS/ 1440P@60FPS/1080P@120FPS/ 1080P@60FPS/1080P@50FPS/1080P@30FPS
EIS	6-DoF EIS
Lens	FOV D:155° H:135° V:77°
ISO	Auto
Shutter	Auto
Video File Format	MP4
WiFi	2.4G
APP	Android,IOS
Interface	Type-C/HDMI
Working Current	Max 500mA@ DC 5V
Run Time	60Mins/4K30fps 110Mins/1080p60fps 135Mins/1080p30fps
Net weight	49g(with battery)/35g(without battery)
Dimensions	66.5*40*20mm